

Oil-injected screw compressor stage

EU 75 Series

Air end data

power consumption at	
driving shaft recommended [kW]	75
volume flow max [m ³ /min]	15.8
discharge pressure max. [bar a]	16
male rotor speed max. [rpm]	3,600
lobe combination	5/6

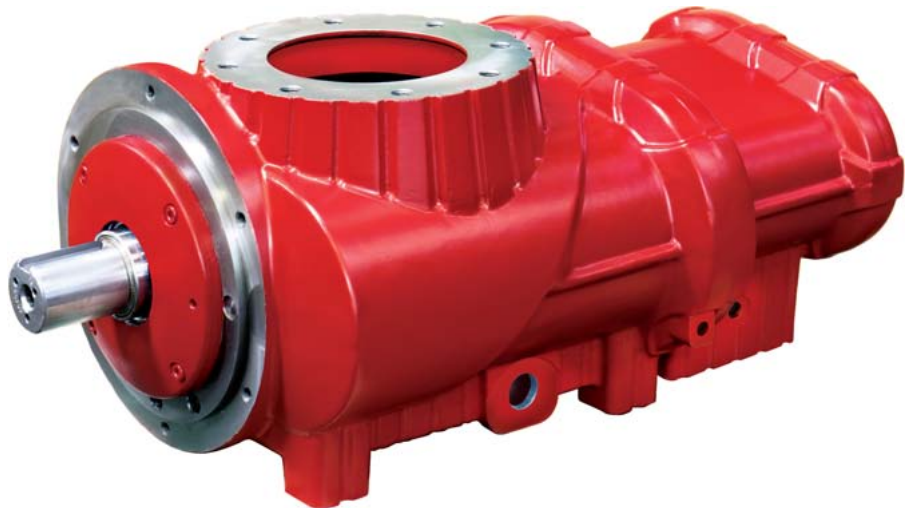
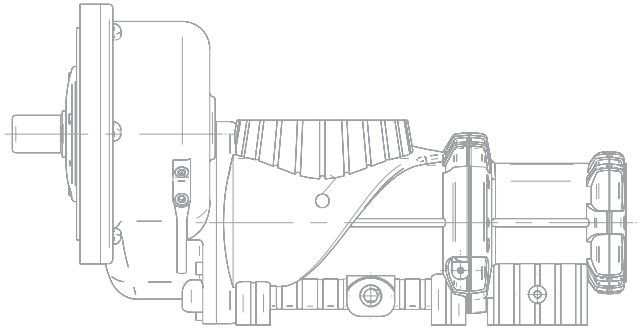
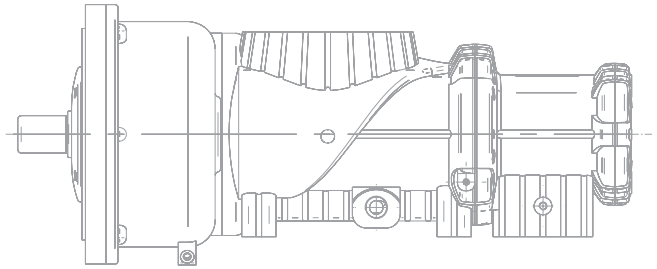

EU 75 Series

Performance data

Performance statements according to ISO 1217

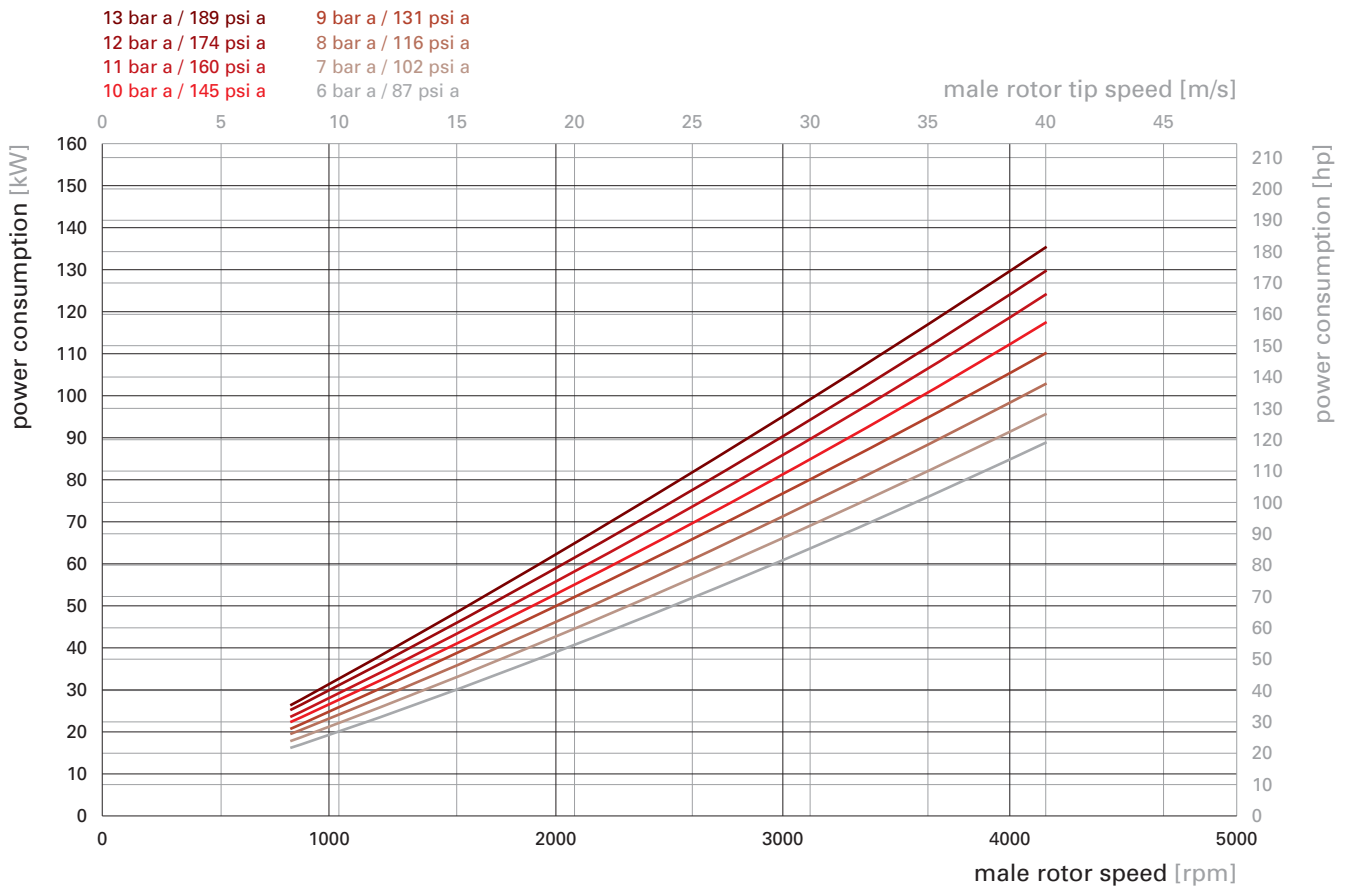
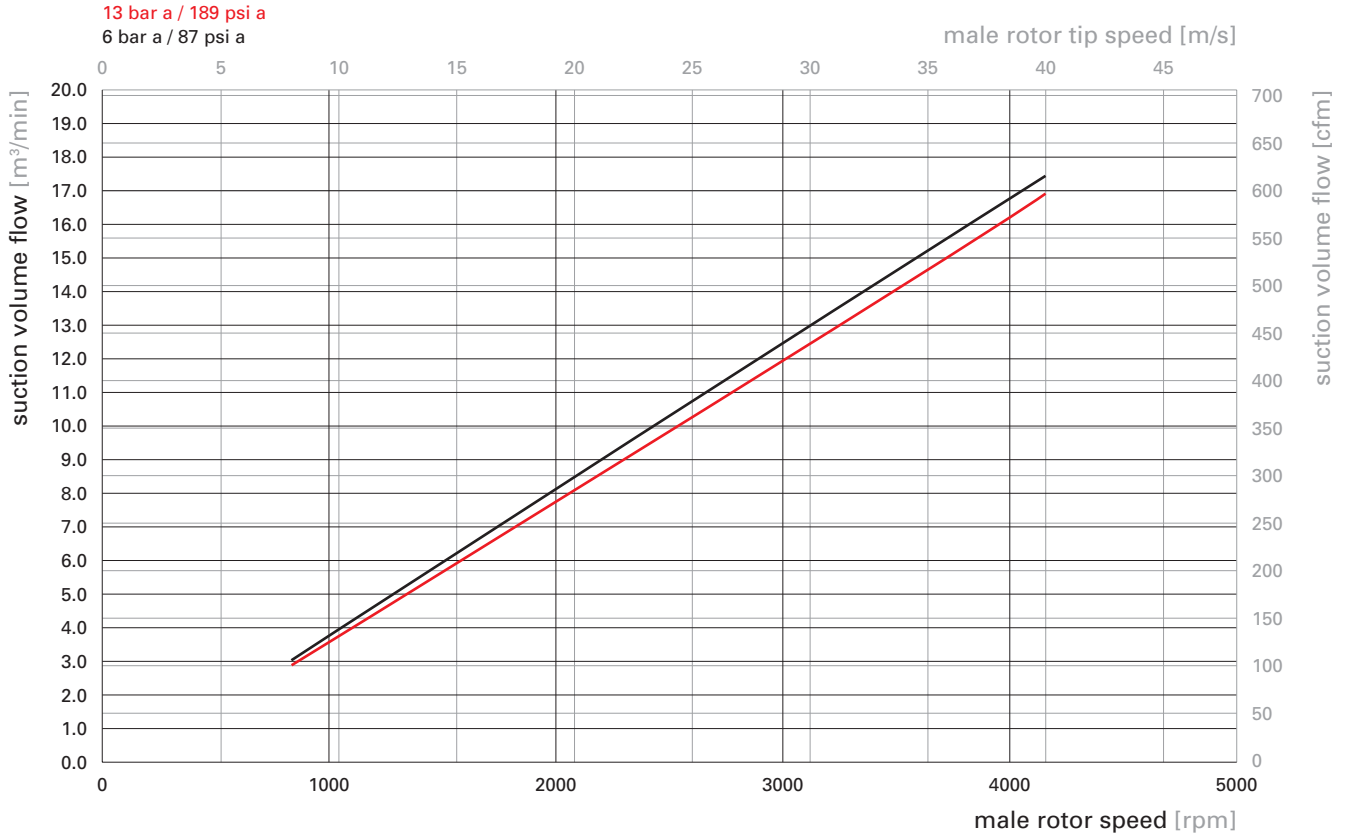

Oil-injected screw compressor stage

EU 75 GV

Installation drawing [mm]

weight [kg] 283.5

