

Oil-injected screw compressor stage

EU 18 Series

Air end data

power consumption at

driving shaft recommended [kW] 18

volume flow max [m³/min] 4.3

discharge pressure max. [bar a] 16

male rotor speed max. [rpm] 7,000

lobe combination 5/6

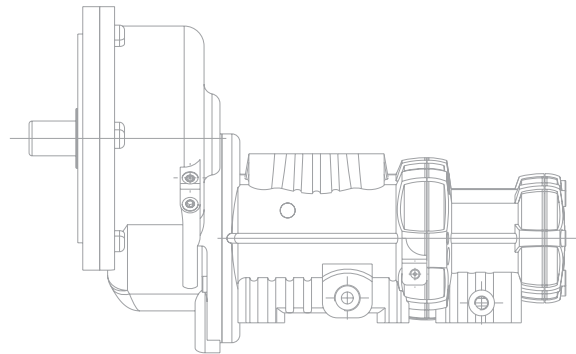
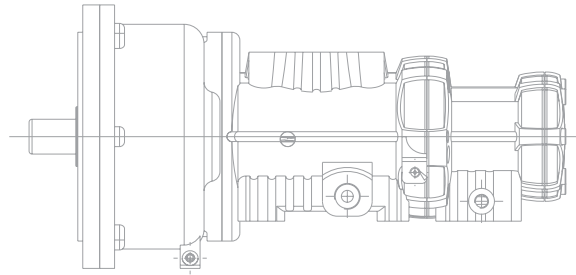

EU 18 Series

Performance data

Performance statements according to ISO 1217

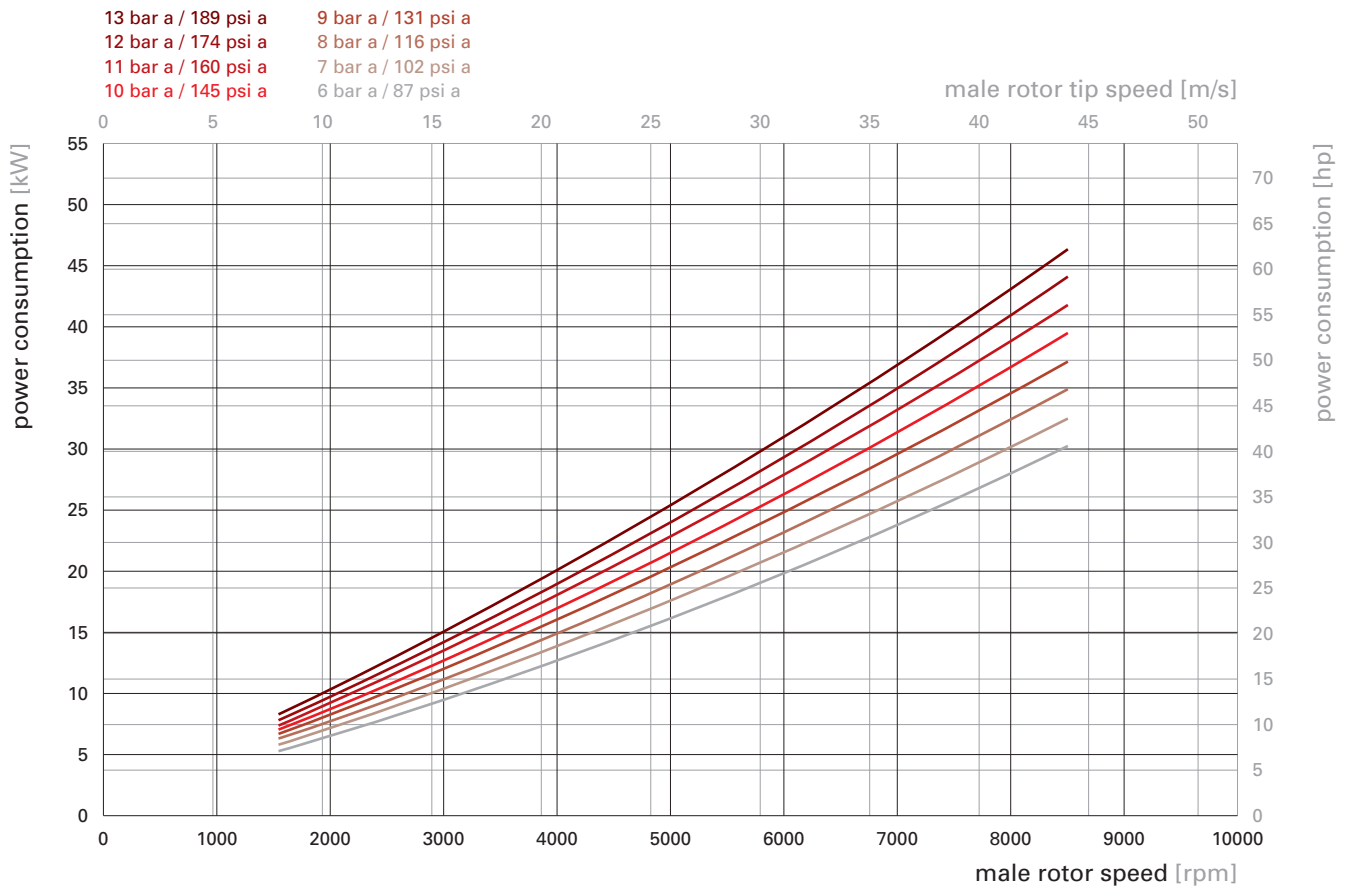
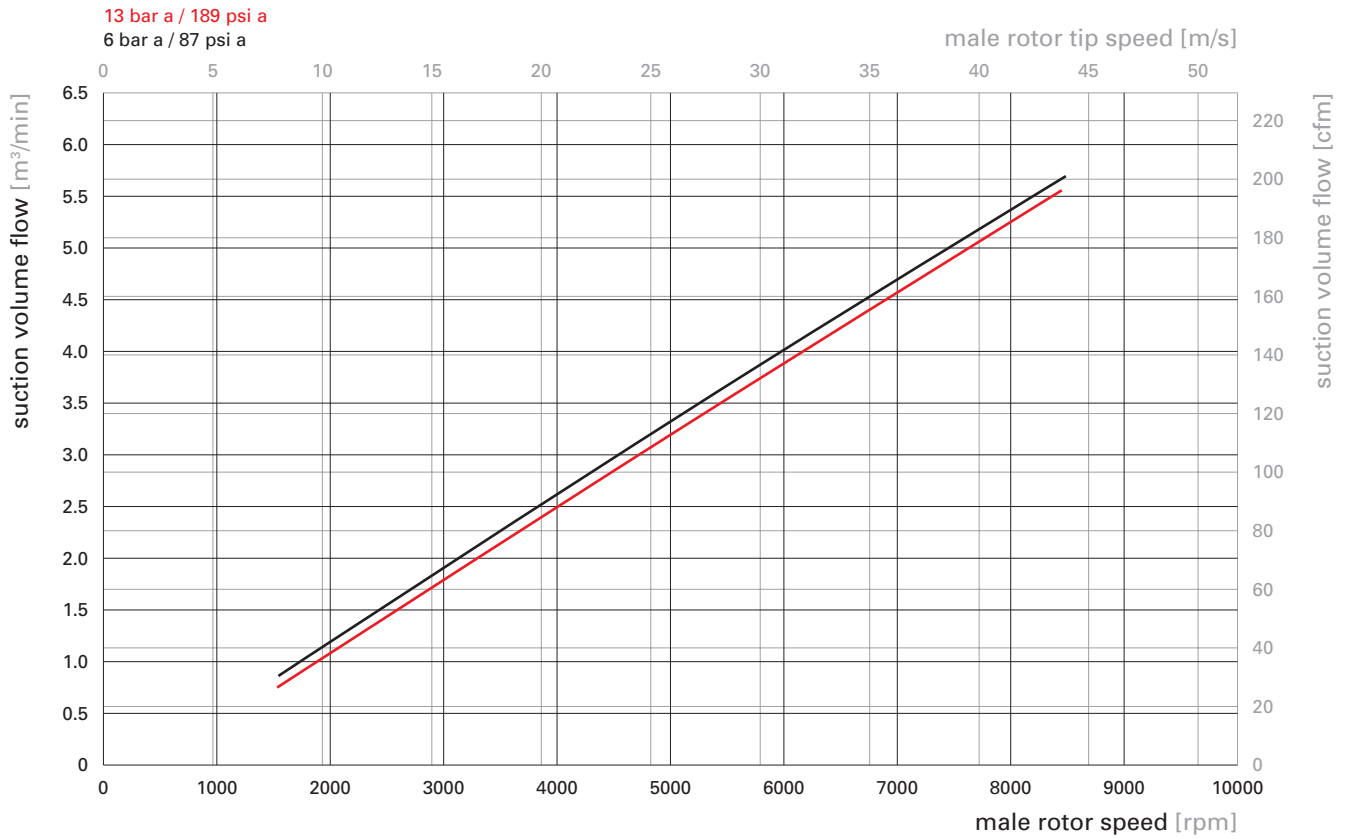

Oil-injected screw compressor stage

EU 18 GV

Installation drawing [mm]

weight [kg]

79.5

